

HV.Select Yealink T46S Phone User Guide



April 2020

Confidentiality

All information in this document is provided in confidence as per the terms and conditions of HV.Select and shall not be published or disclosed wholly or in part to any other party without Daisy's prior permission in writing. These obligations shall not apply to information which is published or becomes known legitimately from some source other than Daisy.

Version Control

This document is controlled and issued by the HV.Select Product Manager. Please ensure that you have the latest version of this document, please check with your Account Manager.

Description of change	Issue	Date
New document in support of product launch	1.0	16 July 2018

Table of Contents

Confidentiality	1
Version Control	2
Yealink SIP-T46S	4
Phone Installation	5
Provisioning	8
Getting to know your phone	9
<i>Hardware Component Instructions</i>	9
<i>Icon Instructions</i>	10
<i>Phone Display (Views)</i>	11
Basic Call Features.....	12
<i>Placing Calls</i>	12
<i>Answering Calls</i>	13
<i>Transferring Calls</i>	13
<i>Ending Calls</i>	14
<i>Conference Calls</i>	14
<i>Do Not Disturb (DND)</i>	14
<i>History</i>	14
<i>Contact Directory</i>	15
<i>Voicemail</i>	15
General information	16

Yealink SIP-T46S

HV.Select IP Phone User guide



This user guide provides you with all the information you need to get the most from your phone. You must first set up your phone before you can use it. This doesn't take long as it is easy to do. Just follow the simple instructions in this user guide or the quick start guide included with the phone.

Got everything?

- IP Phone
- Handset
- Handset cord
- Ethernet cable
- Phone stand
- Quick start guide
- Power adapter (Optional)
- Wall mount bracket (Optional)

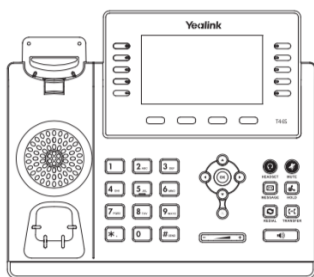

IP Phone



Handset



Handset Cord



Quick Start Guide



Ethernet Cable
(2m CAT5E FTP Cable)

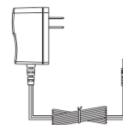

Power Adapter
(Optional)

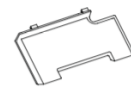

Stand

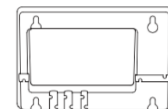

Wall Mount Bracket
(Optional)

Emergency Calls – important information please note

Access to Emergency Services is provided but calls including emergency calls to 999 or 112, made via WHC may not work in the event of power or broadband connection failure. These failures may be caused by reasons outside our control. Location information, provided to the emergency services, is limited to the location details entered into the system by your Service Provider; this may not be where the call was originated.

Phone Installation

1. Attach the stand or the optional wall mount bracket

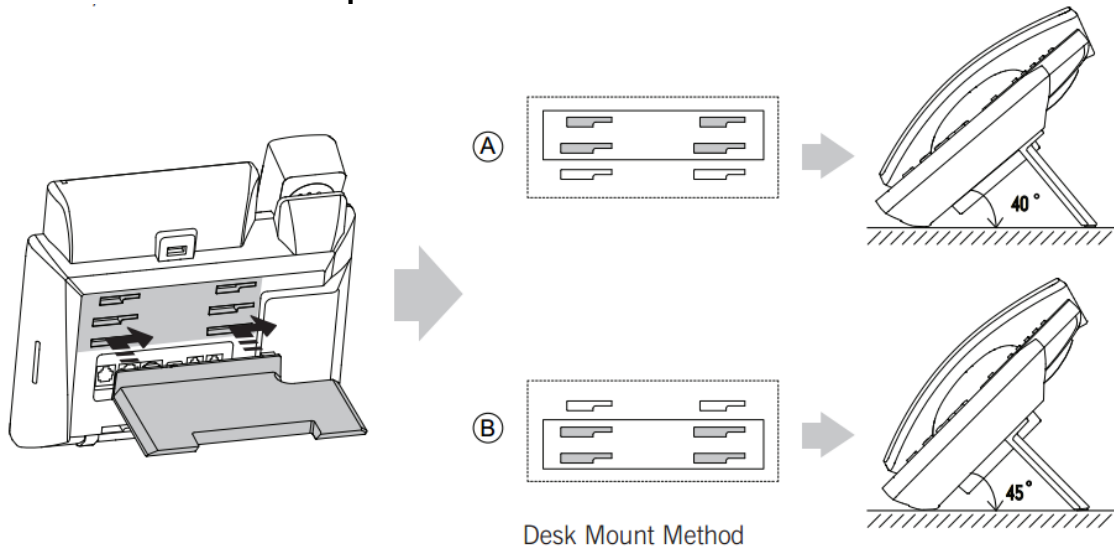

Wall Mount Method (Optional)

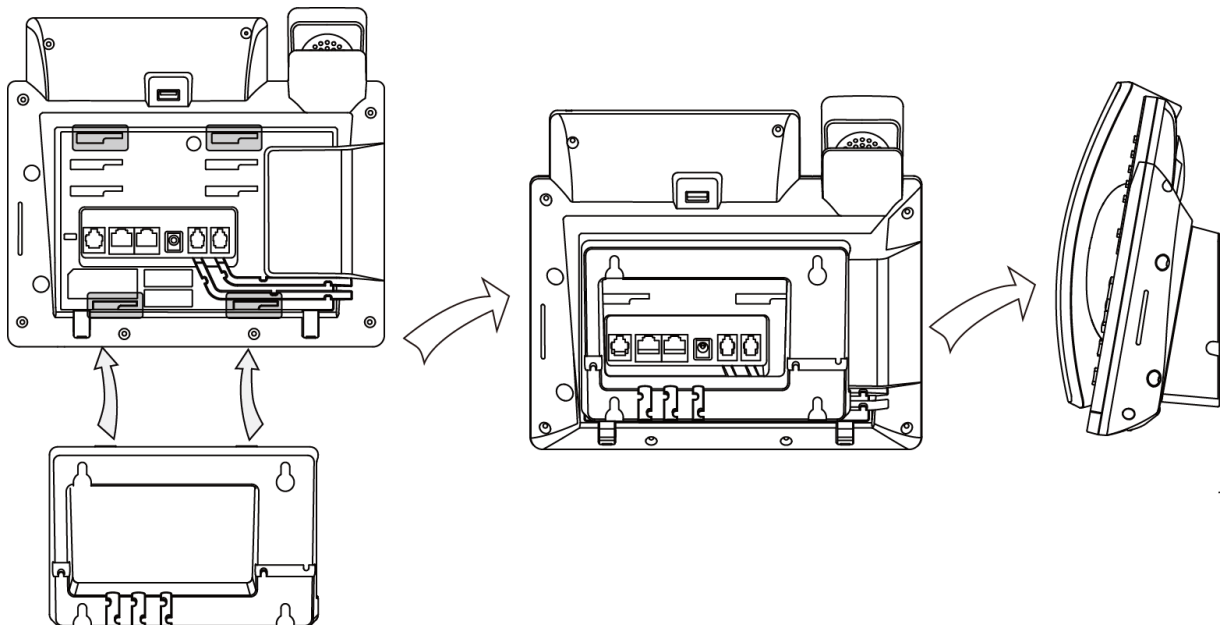

2. Connect the handset and optional headset

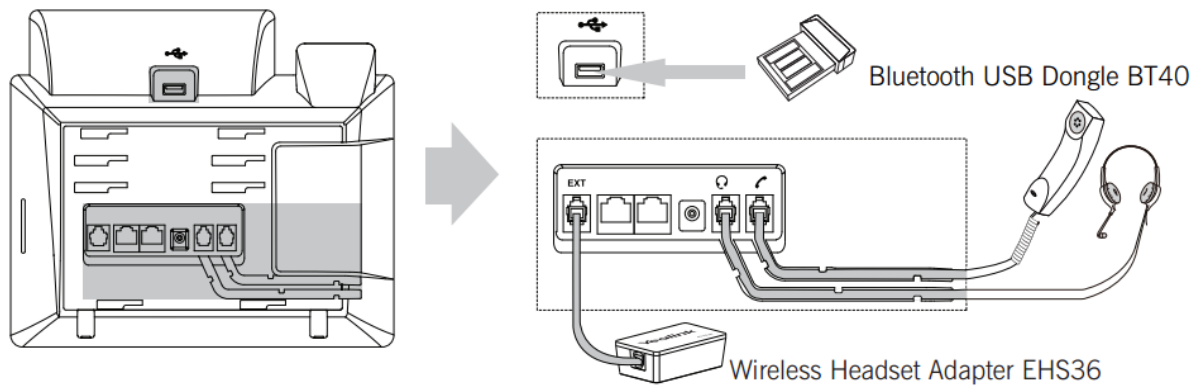

3. Connect the network and power

You have two options for power and network connections. Your system administrator will advise you which one to use.

- AC power (Optional)
- Power over Ethernet (PoE)

AC Power (Optional)

To connect the AC power:

1. Connect the DC plug on the power adapter to the DC5V port on the phone and connect the other end of the power adapter into an electrical power outlet.
2. Connect the included or a standard Ethernet cable between the Internet port on the phone and the one on the wall or switch/hub device port.

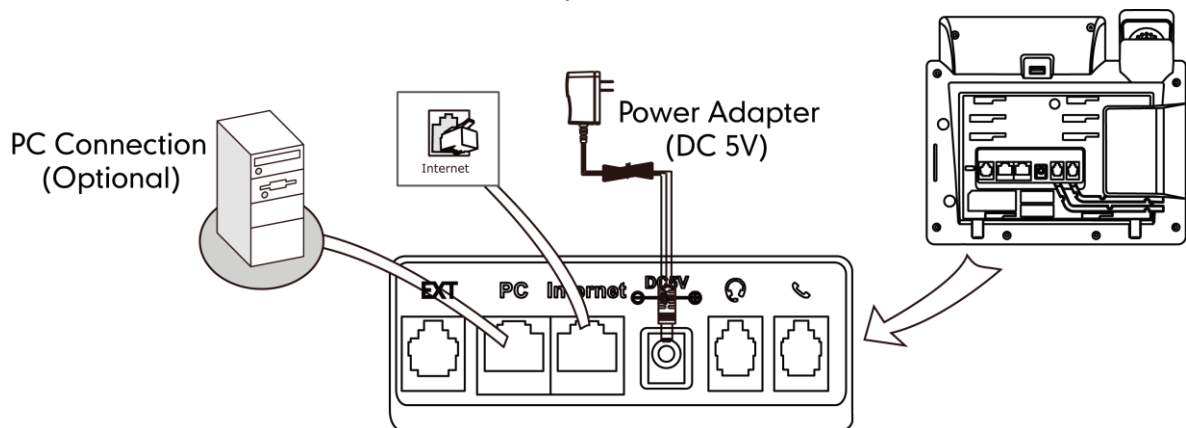

Power over Ethernet

With the included or a regular Ethernet cable, the SIP-T46S IP phone can be powered from a PoE-compliant switch or hub. To connect the PoE:

1. Connect the Ethernet cable between the Internet port on the phone and an available port on the in-line power switch/hub.

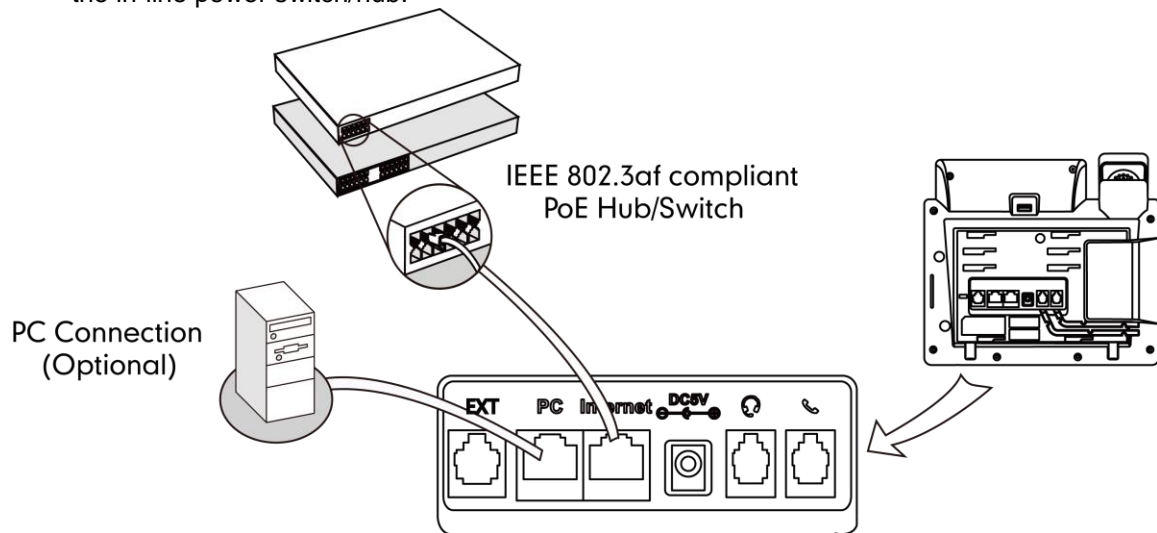

If in-line power switch/hub is provided, you don't need to connect the phone to the power adapter. Make sure the switch/hub is PoE-compliant. The phone can also share the network with another network device such as a PC (personal computer). It is an optional connection. Important, do not unplug or remove power to the phone while it is updating firmware and configurations.

Provisioning

Your Yealink SIP-T46S IP Phone will be pre-loaded with all the information it needs to automatically provision the HVS service once all the connections have been made.

1. Once connected to the network port that is providing network access the phone will do a series of firmware updates (please allow the phone time to complete).

- Your phone has provisioned correctly if this symbol is showing against the phones line key
- Your phone has not provisioned correctly if this symbol is showing against the phones line key



2. Once complete the phone will now show the line number against a line key.



Note: If the handset fails to provision please contact your Service Provider.



Getting to know your phone

Hardware Component Instructions

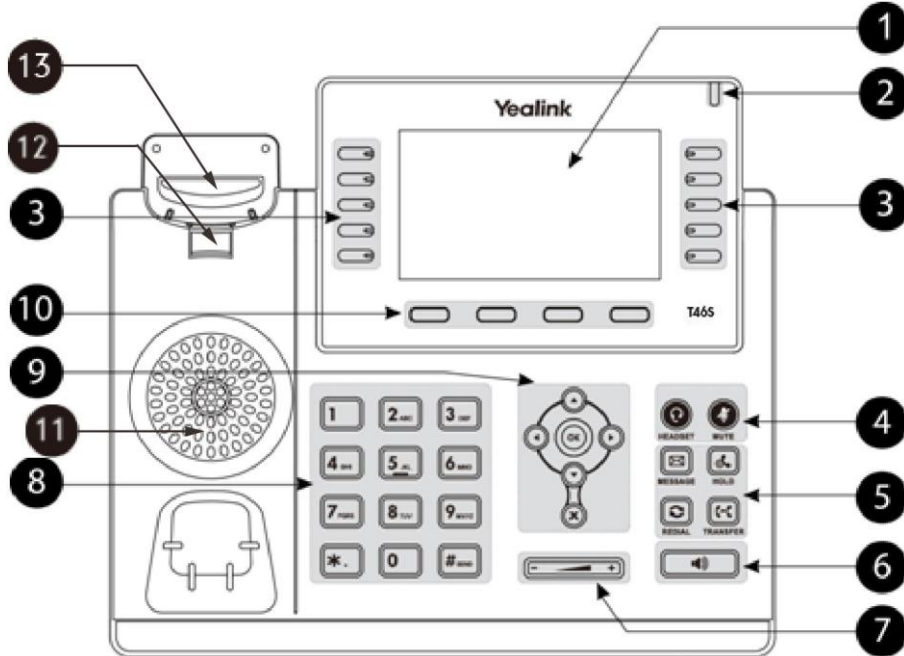
The main hardware components of the SIP-T46S IP phone are the LCD screen and the keypad.





















	Item	Description
①	LCD Screen	Shows information about calls, messages, soft keys, time, date and other relevant data: <ul style="list-style-type: none"> • Call information—caller ID, call duration • Icons (for example, 📞) • Missed call text or second incoming caller information • Prompt text (for example, "Saving config file!") • Time and date
②	Power Indicator LED	Indicates phone power and some feature statuses.
③	Line Keys	Use the Feature Management Portal to assign additional phone lines or Speed Dials to these keys.
④	HEADSET Key	Toggles and indicates the headset mode.
	MUTE Key	Toggles and indicates mute feature.
⑤	MESSAGE Key	Accesses voice messages.
	HOLD Key	Places a call on hold or resumes a held call.
	REDIAL Key	Redials a previously dialled number.
	TRANSFER Key	Transfers a call to another party.
⑥	Speakerphone Key	Toggles the hands-free speakerphone mode.
⑦	Volume Key	Adjusts the volume of the handset, headset, speaker, and ringer.

⑧	Keypad	Provides the digits, letters and special characters in context-sensitive applications.
⑨		Scroll through the displayed information.
		Confirms actions or answers incoming calls.
		Cancels actions or rejects incoming calls.
⑩	Soft Keys	These provide standard function keys that interact with the service such as Hold or Transfer. Using the Feature Management Portal, these can be removed or moved to different positions.
⑪	Speaker	Provides ringer and hands-free (speakerphone) audio output.
⑫	Hookswitch Tab	Secures the handset in the handset cradle when the IP phone is mounted vertically.
⑬	Hookswitch	Picking up the handset from the handset cradle, the hookswitch bounces and the phone connects to the line, laying the handset down on the handset cradle, the phone disconnects from the line.

Icon Instructions

Icons appearing on the LCD screen are described in the following table:

Icons	Description
	Network is unavailable
	Registered successfully
	Register failed
	Registering
	Hands-free speakerphone mode
	Handset mode
	Headset mode
	Multi-lingual lowercase letters input mode
	Multi-lingual uppercase letters input mode
	Alphanumeric input mode
	Numeric input mode
	Multi-lingual uppercase and lowercase letters input mode
	Voice Mail
	Text Message
	Auto Answer
	Do Not Disturb
	Call Forward
	Call Hold

Icons	Description
	Call Mute
	Ringer volume is 0
	Phone Lock
	Received Calls
	Placed Calls
	Missed Calls
	Recording box is full
	A call cannot be recorded
	Recording starts successfully
	Recording cannot be started
	Recording cannot be stopped
	Bluetooth
	Bluetooth headset is both paired and connected
	Conference
	The contact icon
	The default caller photo

Phone Display (Views)

Idle Status



Idle Screen description:

No.	Description
1	This area shows the phone's time, date and feature status.
2	This area shows the line key labels. You can customize the line key as other functions.
3	This area shows three page icons.

4	This area shows the soft key labels. The default soft key labels are “History”, “Directory”, “DND” and “Menu”.
5	This area shows the wallpaper which can be customized.



Phone Status

You can view phone status via phone user interface or web user interface.

Available information of phone status includes:

- Network status (e.g., IPv4 status, IP address mode, MAC address, LAN type, LAN IP and LAN mask).
- Phone status (e.g., device model, hardware version, firmware version and product ID).
- Account status (e.g., register status of SIP accounts).

To view the phone status via phone user interface:

1. Press  , or press **Menu->Status**.
2. Press  or  to scroll through the list and view the specific information.



Time and Date

The time and date is set by the Service Provider. however you can change the format within the phone preferences from basic settings.

Basic Call Features

Placing Calls



You can place a call in three ways using your SIP-T46S IP phone:

- Using the handset
- Using the speakerphone
- Using the headset

You can also dial the number first, and then choose the way you want to speak to the other party.



You can also search and dial a contact from call history, local directory or remote phone book. During a call, you can alternate between Speakerphone, Headset, or Handset mode by pressing the Speakerphone key, the Headset key, or picking up the handset.

To place a call using the handset:



1. Pick up the handset.
2. Enter the desired number using the keypad.
3. Press  ,  , or the Send soft key.

To place a call using the headset:

With the optional headset connected, press  to activate the headset mode.

1. Press the line key to obtain a dial tone.
2. Enter the desired number using the keypad.
3. Press  ,  , or the **Send** soft key.

With the optional headset connected, press  to activate the headset mode.

1. Enter the desired number using the keypad.
2. Press  ,  , or the **Send** soft key.

Answering Calls

To answer a call using the handset:

1. Pick up the handset.

To answer a call using the hands-free speakerphone mode:

1. Press  .
2. With the handset on-hook and the headset mode deactivated, press the **Answer** soft key.
3. With the handset on-hook and the headset mode deactivated, press the line key (the line key LED flashes green).

To answer a call using the headset:

1. Press  .
2. With the headset mode activated, press the **Answer** soft key.
3. With the headset mode activated, press the line key (the line key LED flashes green).

Transferring Calls

You can transfer a call to another party in one of the three ways:

- Blind Transfer: Transfer a call directly to another party without consulting.
- Semi-Attended Transfer: Transfer a call when the target phone is ringing.
- Attended Transfer: Transfer a call with prior consulting.



To perform a blind transfer:

1. Press the **Tran** soft key during a call.
2. Enter the number you want to transfer the call to.
3. Press the **Tran** soft key to complete the transfer.



Then the call is connected to the number to which you are transferring.

To perform a semi-attended transfer:

1. Press the **Tran** soft key during a call.

2. Do one of the following:
 - Enter the number you want to transfer the call to.
 - Press the **Directory** soft key to find the number of directory or History.
3. Press  or  to dial out.
4. Press the **Tran** soft key to complete the transfer when receiving ringback.

To perform an attended transfer:



1. Press the **Tran** soft key during a call.
2. Do one of the following:
 - Enter the number you want to transfer the call to.
 - Press the **Directory** soft key to find the number of directory or history.
3. Press  or  to dial out.
4. After the party answers the call, press the **Tran** soft key to complete the transfer.

If you are using a handset, the transfer can be completed by hanging up the handset. You can cancel the transfer before the call is connected by pressing the **Cancel** soft key.

Ending Calls

1. If you are using the handset, press the **Cancel** soft key or hang up the handset.
2. If you are using the headset, press the **Cancel** soft key.
3. If you are using the speakerphone, press  or the **Cancel** soft key.

Conference Calls

1. When the first party answers the call, press the **Conf** soft key to place a new call.
2. The active call is placed on hold.
3. Enter the number of the second party and press , , or the **Send** soft key.
4. When the second party answers the call, press the **Conf** soft key again to join all parties in the conference.

During the conference call, you can do the following:





- Press the **Hold** soft key to place the conference on hold.
- Press the **Split** soft key to split the conference call into two individual calls.
- Press the **New Call** soft key to place a new call.
- Press the **Back** soft key to return to the previous interface.
- Press  to mute the conference call.
- Press the **Cancel** soft key to drop the conference call.

Do Not Disturb (DND)





Press the **DND** soft key when the phone is idle. The **DND** icon on the idle screen indicates that DND is enabled. Incoming calls will be rejected automatically and "**n Missed Call(s)**" ("n" indicates the number of the missed calls) will prompt on the LCD screen.

History

To view the call history:

1. Press the **History** soft key. The LCD screen displays all call records.
2. Press  or  to switch between All, Placed, Received, Missed and Forwarded call lists.
3. Press  or  to select the desired entry.
4. Press the **Option** soft key, and then select Detail from the prompt list. The detailed information of the entry appears on the LCD screen.

To place a call from the call history list:

1. Press the History soft key.
2. Press  or  to switch between All, Placed, Received, Missed and Forwarded call lists.
3. Press  or  to select the desired entry.
4. Press the Send soft key.

Contact Directory

You can add local contacts, search for a contact, or simply dial a contact number from the corporate directory.

To access your corporate directory

1. Press **Directory** Softkey
2. Select the desired remote group, and then press the **Enter** soft key.
3. The phone connects to load the corporate directory, and then the corporate contact list appears on the LCD screen.
4. Press the **Back** soft key to back to the previous interface.
5. Rectory and tap the contact. From the contact's information screen, tap the contact's phone number.

To search for a contact in the corporate directory:

1. Press **Directory** Softkey
2. Select the desired remote group, and then press the **Enter** soft key to load the corporate directory.
3. Press the **Search** soft key.
4. Enter a few continuous characters of the contact name or continuous numbers of the contact number using the keypad.
The contacts whose name or phone number matches the characters entered will appear on the LCD screen. You can place a call from the result list.

Voicemail

When receiving a new voice mail, the phone will play a warning tone, and the power indicator LED will slow flash red. The LCD screen will display a prompt message and appear an icon.

1. When the phone user interface prompts receiving new voice mails and the power indicator LED slow flashes red, press  or the **Connect** soft key to dial out the voice mail access code.
2. Follow the voice prompt to listen to voice mails.

General information

Important

- Access to Emergency Services is provided but calls including emergency calls to 999 or 112, made via HVS may not work in the event of power or broadband connection failure. These failures may be caused by reasons outside our control. Location information, provided to the emergency services, is limited to the location details entered into the system by your Service Provider; this may not be where the call was originated.

Safety information

- Do not open the handset or the base. This could expose you to high voltages or other risks. Contact your Service Provider for all repairs.

Cleaning

- Clean the handset and base with a damp (not wet) cloth, or an anti-static wipe. Never use household polish as this will damage the product. Never use a dry cloth as this may cause a static shock.

Environmental

- Do not expose to direct sunlight
- Do not stand your product on carpets or other surfaces which generate fibres, or place it in locations preventing the free flow of air over its surfaces
- Do not submerge any part of your product in water and do not use it in damp or humid conditions, such as bathrooms
- Do not expose your product to fire, explosive or other hazardous conditions
- There is a slight chance your phone could be damaged by an electrical storm.

Product disposal instructions

- The symbol shown here and on the product means that the product is classed as Electrical or Electronic Equipment and should not be disposed with other household or commercial waste at the end of its working life.
- The Waste of Electrical and Electronic Equipment (WEEE) Directive (2002/96/EC) has been put in place to recycle products using best available recovery and recycling techniques to minimize the impact on the environment, treat any hazardous substances and avoid the increasing landfill.
- Business users should contact their suppliers and check the terms and conditions of the purchase contract and ensure that this product is not mixed with other commercial waste for disposal.



Guarantee

- Your IP Phone is guaranteed for a period of 12 months from the date of purchase.
- Subject to the terms listed below, the guarantee will provide for the repair of, or at the Service Provider or its agent's discretion, the option to replace the Phone or any component thereof, (other than batteries), which is identified as faulty or below standard, or as a result of inferior workmanship or materials. Products over 28 days old from the date of purchase may be replaced with a refurbished or repaired product.

The conditions of this guarantee are:

- The guarantee shall only apply to defects that occur within the 12-month guarantee period
- Proof of purchase is provided
- The equipment is returned to your Service Provider or its agent as instructed
- This guarantee does not cover any faults or defects caused by accidents, misuse, fair wear and tear, neglect, tampering with the equipment, or any attempt at adjustment or repair other than through approved agents
- This guarantee does not affect your statutory rights.

